

**PNP Silicon AF Transistors**

Preliminary data

- For AF input stages and driver applications
- High current gain
- Low collector-emitter saturation voltage
- Complementary types: BC847BL3,  
BC848BL3 (NPN)

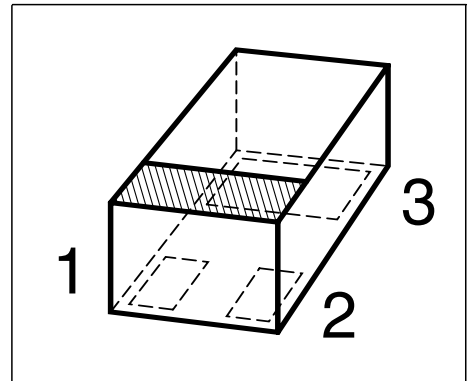

Type	Marking	Pin Configuration			Package
		1 = B	2 = E	3 = C	
BC857BL3	3F	1 = B	2 = E	3 = C	TSLP-3-1
BC858BL3	3K	1 = B	2 = E	3 = C	TSLP-3-1

**Maximum Ratings**

Parameter	Symbol	Value	Unit
Collector-emitter voltage	$V_{CEO}$		V
BC857BL3		45	
BC858BL3		30	
Collector-emitter voltage	$V_{CES}$		
BC857BL3		50	
BC858BL3		30	
Collector-base voltage	$V_{CBO}$		
BC857BL3		50	
BC858BL3		30	
Emitter-base voltage	$V_{EBO}$		
BC857BL3		5	
BC858BL3		5	
Collector current	$I_C$	100	mA
Peak collector current	$I_{CM}$	200	
Total power dissipation	$P_{tot}$	250	mW
$T_S \leq 138^\circ\text{C}$			
Junction temperature	$T_j$	150	$^\circ\text{C}$
Storage temperature	$T_{stg}$	-65 ... 150	

**Thermal Resistance**

Parameter	Symbol	Value	Unit
Junction - soldering point <sup>1)</sup>	$R_{thJS}$	$\leq 50$	K/W

<sup>1)</sup>For calculation of  $R_{thJA}$  please refer to Application Note Thermal Resistance

**Electrical Characteristics** at  $T_A = 25^\circ\text{C}$ , unless otherwise specified

Parameter	Symbol	Values			Unit
		min.	typ.	max.	
<b>DC Characteristics</b>					
Collector-emitter breakdown voltage $I_C = 10\text{ mA}$ , $I_B = 0$ , BC857BL3 $I_C = 10\text{ mA}$ , $I_B = 0$ , BC858BL3	$V_{(BR)CEO}$	45 30	- -	- -	V
Collector-base breakdown voltage $I_C = 10\text{ }\mu\text{A}$ , $I_E = 0$ , BC857BL3 $I_C = 10\text{ }\mu\text{A}$ , $I_E = 0$ , BC858BL3	$V_{(BR)CBO}$	50 30	- -	- -	
Collector-emitter breakdown voltage $I_C = 10\text{ }\mu\text{A}$ , $V_{BE} = 0$ , BC857BL3 $I_C = 10\text{ }\mu\text{A}$ , $V_{BE} = 0$ , BC858BL3	$V_{(BR)CES}$	50 30	- -	- -	
Emitter-base breakdown voltage $I_E = 0$ , $I_C = 1\text{ }\mu\text{A}$	$V_{(BR)EBO}$	5	-	-	
Collector-base cutoff current $V_{CB} = 30\text{ V}$ , $I_E = 0$ $V_{CB} = 30\text{ V}$ , $I_E = 0$ , $T_A = 150\text{ }^\circ\text{C}$	$I_{CBO}$	- -	- -	15 5	nA
DC current gain- $I_C = 10\text{ }\mu\text{A}$ , $V_{CE} = 5\text{ V}$ $I_C = 2\text{ mA}$ , $V_{CE} = 5\text{ V}$	$h_{FE}$	- 220	250 290	- 475	-
Collector-emitter saturation voltage <sup>1)</sup> $I_C = 10\text{ mA}$ , $I_B = 0.5\text{ mA}$ $I_C = 100\text{ mA}$ , $I_B = 5\text{ mA}$	$V_{CEsat}$	- -	75 250	300 650	mV
Base emitter saturation voltage- <sup>1)</sup> $I_C = 10\text{ mA}$ , $I_B = 0.5\text{ mA}$ $I_C = 100\text{ mA}$ , $I_B = 5\text{ mA}$	$V_{BEsat}$	- -	700 850	- -	
Base-emitter voltage- <sup>1)</sup> $I_C = 2\text{ mA}$ , $V_{CE} = 5\text{ V}$ $I_C = 10\text{ mA}$ , $V_{CE} = 5\text{ V}$	$V_{BE(ON)}$	600 -	650 -	750 820	

**AC Characteristics**

Transition frequency $I_C = 20 \text{ mA}$ , $V_{CE} = 5 \text{ V}$ , $f = 100 \text{ MHz}$	$f_T$	-	250	-	MHz
Collector-base capacitance $V_{CB} = 10 \text{ V}$ , $f = 1 \text{ MHz}$	$C_{cb}$	-	3	-	pF
Emitter-base capacitance $V_{EB} = 0.5 \text{ V}$ , $f = 1 \text{ MHz}$	$C_{eb}$	-	8	-	
Short-circuit input impedance $I_C = 2 \text{ mA}$ , $V_{CE} = 5 \text{ V}$ , $f = 1 \text{ kHz}$	$h_{11e}$	-	4.5	-	k $\Omega$
Open-circuit reverse voltage transf. ratio $I_C = 2 \text{ mA}$ , $V_{CE} = 5 \text{ V}$ , $f = 1 \text{ kHz}$	$h_{12e}$	-	2	-	$10^{-4}$
Short-circuit forward current transf. ratio $I_C = 2 \text{ mA}$ , $V_{CE} = 5 \text{ V}$ , $f = 1 \text{ kHz}$	$h_{21e}$	-	330	-	-
Open-circuit output admittance $I_C = 2 \text{ mA}$ , $V_{CE} = 5 \text{ V}$ , $f = 1 \text{ kHz}$	$h_{22e}$	-	30	-	$\mu\text{S}$

**DC current gain  $h_{FE} = f(I_C)$**

$V_{CE} = 5\text{ V}$

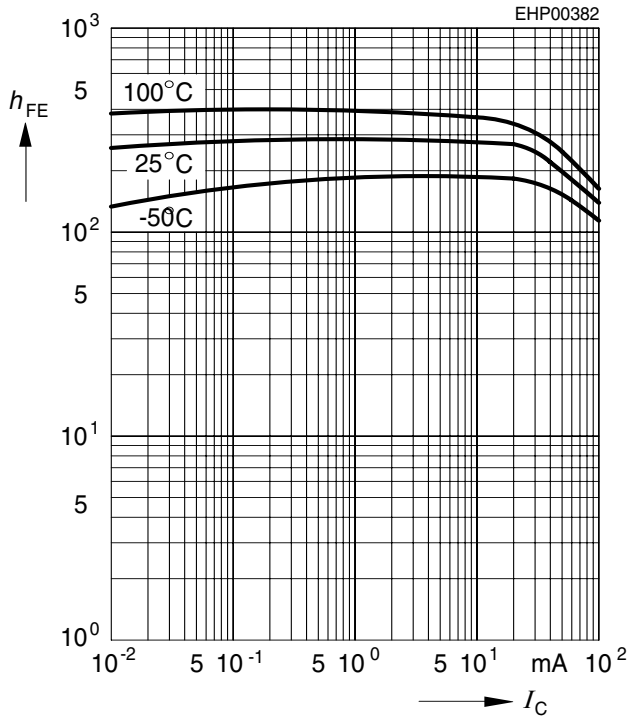

**Collector-emitter saturation voltage**

$I_C = f(V_{CEsat}), h_{FE} = 20$

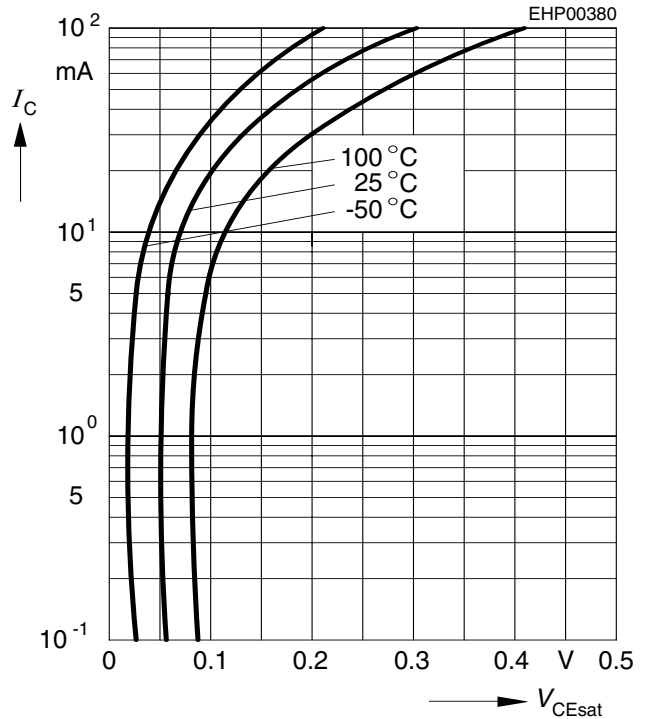

**Base-emitter saturation voltage**

$I_C = f(V_{BEsat}), h_{FE} = 20$

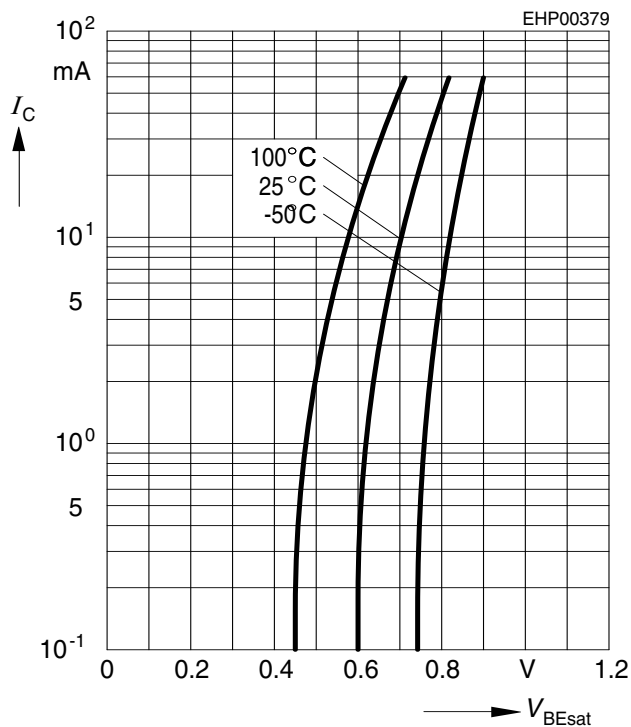

**Collector cutoff current  $I_{CBO} = f(T_A)$**

$V_{CBO} = 30\text{ V}$

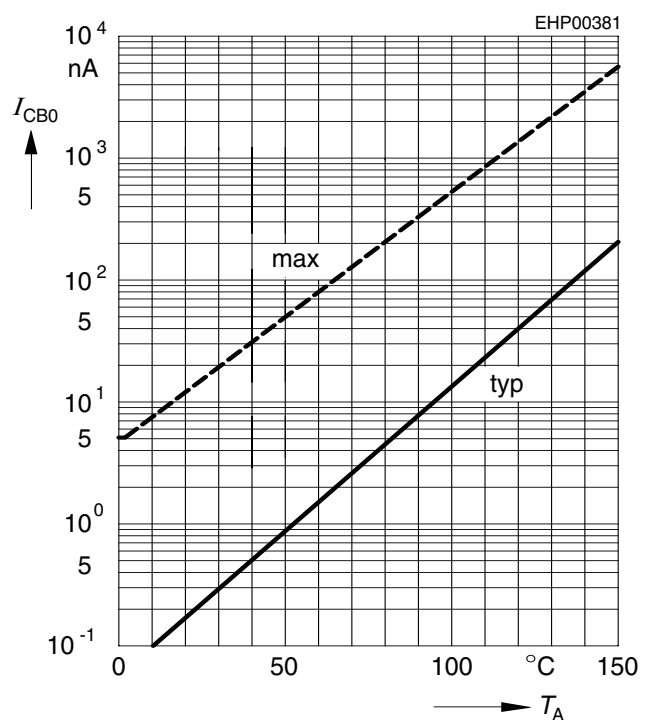

**Transition frequency  $f_T = f(I_C)$**

$V_{CE} = 5\text{ V}$

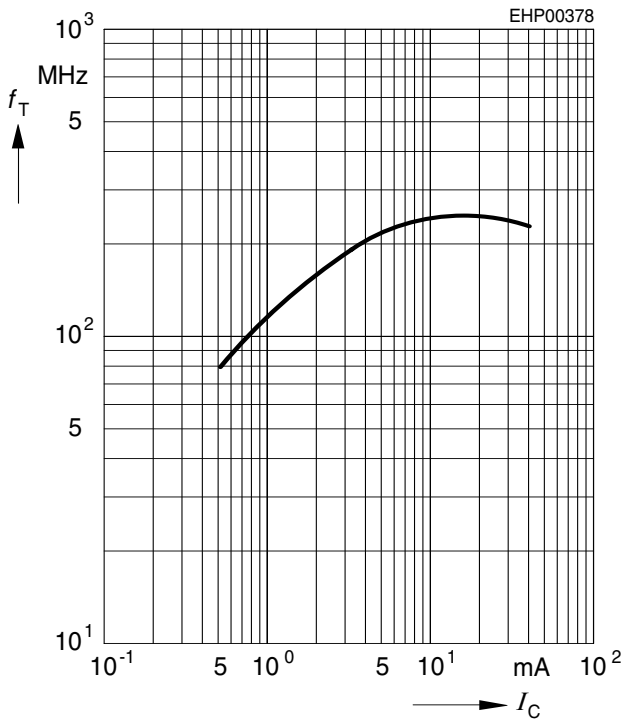

**Collector-base capacitance  $C_{CB} = f(V_{CB0})$**

**Emitter-base capacitance  $C_{EB} = f(V_{EB0})$**

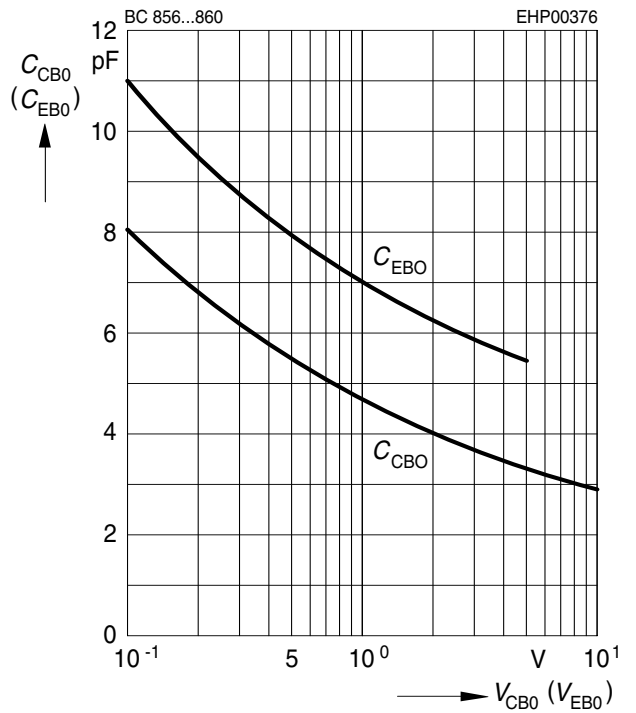

**h parameter  $h_e = f(I_C)$  normalized**

$V_{CE} = 5\text{ V}$

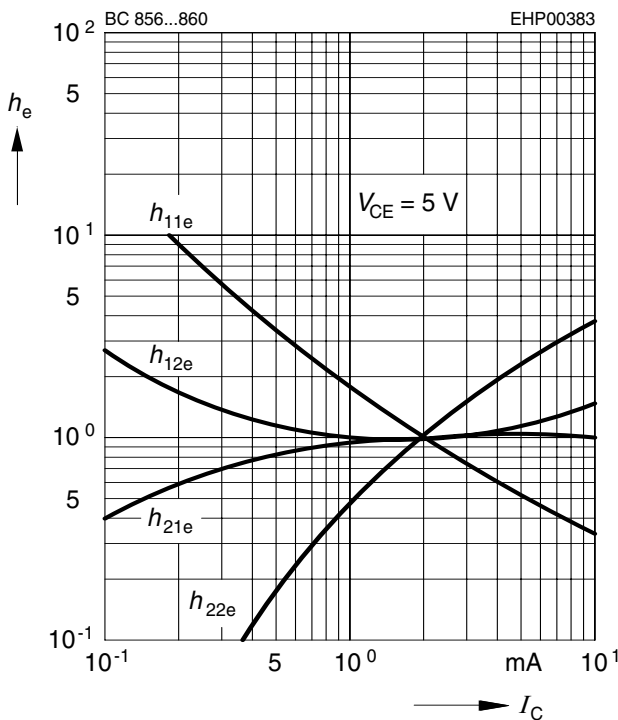

**h parameter  $h_e = f(V_{CE})$  normalized**

$I_C = 2\text{ mA}$

